

MINI-TRUNKING AND ACCESSORIES



VERSIONS

	Version with standard lid
	Version with enveloping lid
	Version with self adhesive bottom

REFERENCE STANDARD

<p>EN 50085-1 Cable trunking systems and cable ducting systems for electrical installations. <i>Parte 1: general requirements.</i></p>
<p>EN 50085-2-1 Cable trunking systems and cable ducting systems for electrical installations. <i>Parte 2-1: cable trunking systems and cable ducting systems intended for mounting on walls and ceiling.</i></p>

QUALITY MARKS



TECHNICAL CHARACTERISTICS

Protection degree:	IP40
Operating ambient temperature according to the reference standard:	+5°C +60°C
Max. operating ambient temperature:	60°C
Glow Wire test:	650°C
Material:	Engineering plastic
Colour:	Grey RAL 7035 White RAL 9003
Impact resistance according to the reference standard:	1 Joule

BEHAVIOUR WITH CHEMICAL AND ATMOSPHERIC AGENTS

Saline solution	Acids		Bases		Solvents				Mineral oil	UV rays
	Concentrated	Diluted	Concentrated	Diluted	Hexane	Benzol	Acetone	Alcohol		
Resistant	Limited Resistance	Resistant	Limited Resistance	Resistant	Not Resistant	Not Resistant	Limited Resistance	Resistant	Resistant	Resistant

APPLICATION EXAMPLES



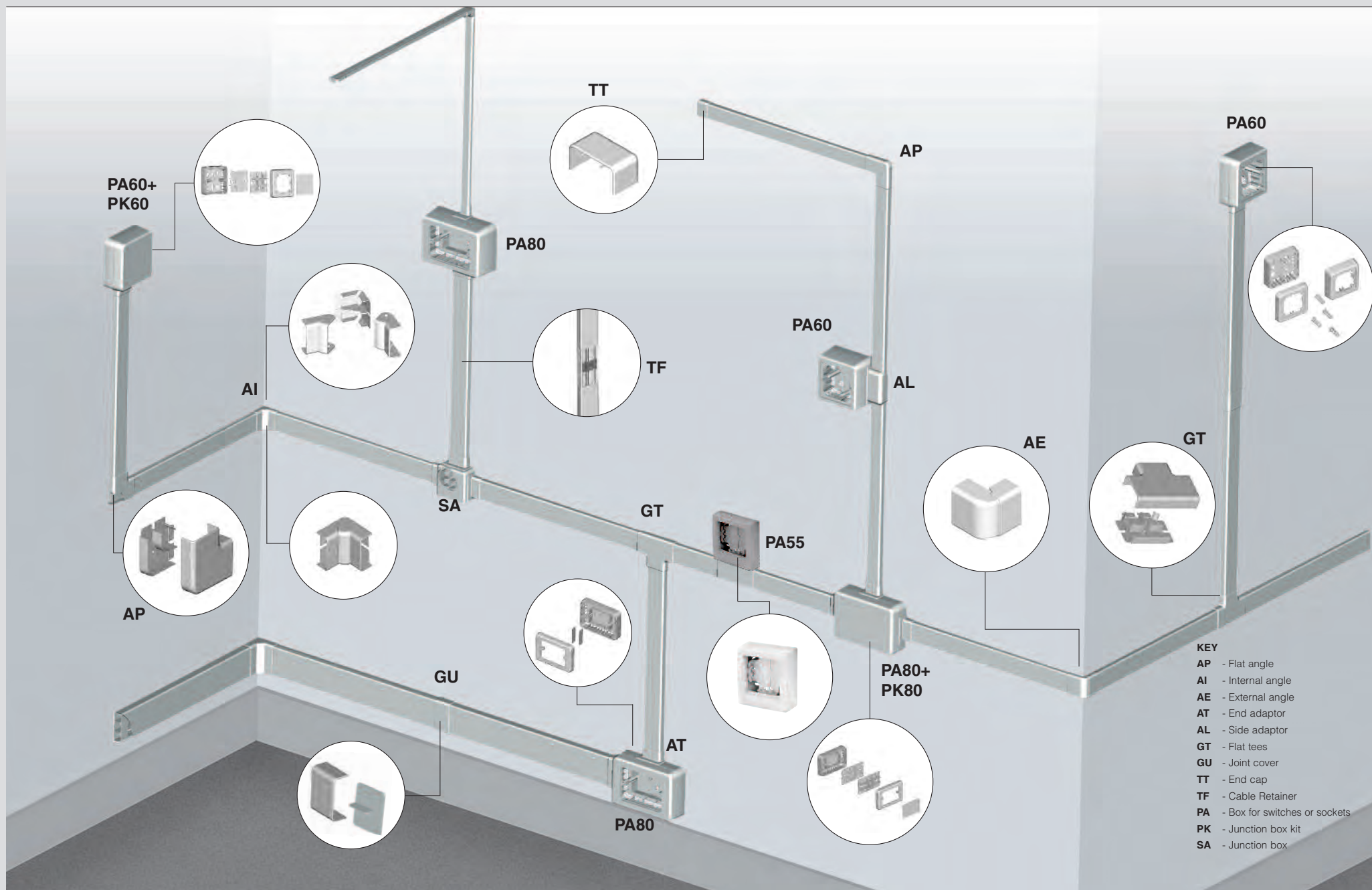

- KEY**
- AP - Flat angle
 - AI - Internal angle
 - AE - External angle
 - AT - End adaptor
 - AL - Side adaptor
 - GT - Flat tees
 - GU - Joint cover
 - TT - End cap
 - TF - Cable Retainer
 - PA - Box for switches or sockets
 - PK - Junction box kit
 - SA - Junction box

WADO Series - Minitrunking







HOW TO CHOOSE THE CORRECT WADO SERIES SCAME MINI-TRUNKING

Note: The maximum allowable number of cables complies with the specifications of IEC 64-8 standards, requiring a capacity factor equal to 50% for the compartments designed to accommodate power cables.

STANDARD LID

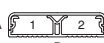





Can be removed:
without any tool

Size w x h (mm)	Number of compartments	A (mm)	B (mm)	Compartment	Compartment section (mm ²)	Total section (mm ²)	CAPACITY			
							Maximum allowable number of cables H07V-U/R/K Cable			
							Section (mm ²)			
1,5	2,5	4	6							
 20x10	1	10	20	1	129	129	5	4	3	2
 20x15	1	15	20	1	170	170	7	5	4	3
 30x15	1	15	30	1	288	288	12	9	7	5
 40x10	2	10	40	1	126	252	5	3	3	2
				2	126		5	3	3	2
 40x15	2	15	40	1	173	346	8	5	4	3
				2	173		8	5	4	3
 40x20	2	20	40	1	259	518	11	8	6	5
				2	259		11	8	6	5
 60x20	3	20	60	1	254	774	11	8	6	5
				2	266		11	8	6	5
				3	254		11	8	6	5

ENVELOPING LID

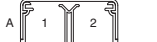

Can be removed
with the aid of a tool

Size w x h (mm)	Number of compartments	A (mm)	B (mm)	Compartment	Compartment section (mm ²)	Total section (mm ²)	CAPACITY			
							Maximum allowable number of cables H07V-U/R/K Cable			
							Section (mm ²)			
1,5	2,5	4	6							
 20x15	1	15	20	1	160	160	8	5	4	3
 30x15	1	15	30	1	278	278	13	9	7	5
 40x15	2	15	40	1	168	336	7	5	4	3
				2	168		7	5	4	3
 40x20	2	20	40	1	248	496	11	8	6	5
				2	248		11	8	6	5
 60x20	2	20	60	1	242	750	12	7	6	5
				2	266		12	8	6	5
				3	242		12	7	6	5

WADO Series - Skirting trunking

SKIRTING TRUNKING AND ACCESSORIES



VERSIONS

	80mm skirting trunking
	120mm skirting trunking
	Floor trunking

REFERENCE STANDARDS

<p>EN 50085-1 Cable trunking systems and cable ducting systems for electrical installations. <i>Parte 1: general requirements.</i></p>
<p>EN 50085-2-1 Cable trunking systems and cable ducting systems for electrical installations. <i>Parte 2-1: cable trunking systems and cable ducting systems intended for mounting on walls and ceiling.</i></p>

QUALITY MARKS



TECHNICAL CHARACTERISTICS

Protection degree:	IP40
Operating ambient temperature according to the reference standard:	+5°C +60°C
Max. operating ambient temperature:	60°C
Glow Wire test:	650°C
Material:	Engineering plastic
Colour:	Grey RAL 7035 White RAL 9003 Anthracite Brown
Impact resistance according to the reference standard:	1 Joule

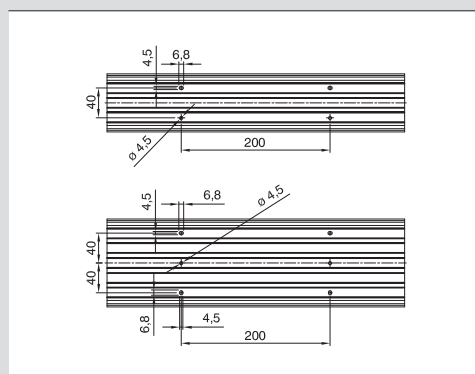

The trunking back is provided with $\varnothing 4.5$ -mm holes and 6.8x4.5-mm slots with 40-mm distance between centres and 200-mm pitch.

BEHAVIOUR WITH CHEMICAL AND ATMOSPHERIC AGENTS

Saline solution	Acids		Bases		Solvents				Mineral oil	UV rays
	Concentrated	Diluted	Concentrated	Diluted	Hexane	Benzol	Acetone	Alcohol		
Resistant	Limited Resistance	Resistant	Limited Resistance	Resistant	Not Resistant	Not Resistant	Limited Resistance	Resistant	Resistant	Resistant

TRUNKING SECTIONS (mm²)

Trunking type	Trunking sections mm ²	Max. number of conductors installable				
		1	2	3	4	5
80-mm skirting trunking 	1,5mm ²	13	14	13		
	2,5mm ²	9	10	9		
	4mm ²	7	8	7		
	6mm ²	5	6	5		
120-mm skirting trunking 	1,5mm ²	14	18	18	18	14
	2,5mm ²	10	12	12	12	10
	4mm ²	8	9	9	9	8
	6mm ²	6	7	7	7	6
Floor trunking 	1,5mm ²	7	8	7		
	2,5mm ²	5	5	5		
	4mm ²	4	4	4		
	6mm ²	3	3	3		

APPLICATION EXAMPLES



WADO Series - Skirting trunking

■ SKIRTING, FLOOR TRUNKING AND ACCESSORIES

80MM VERSION

Offering excellent aesthetic and functional integration with skirting version 120 mm and with mini-trunking by Scame, WADO Series.

KEY

- | | |
|---|---|
| AP - Flat angle | GS - Floor trunking joint |
| AI - Variable internal angle | TT - End cap |
| AE - Variable external angle | TF - Cable retainer |
| CC - Closing cap | TM - Wall passage terminal |
| GT - Flat tees | PA - Box for switches or sockets |
| GU - Joint cover | PB - Box for switches or sockets |
| GM - Flat tees for mini-trunking | SA - Junction box |
| GT - Flat tees | AT - End adaptor (mini-trunking) |

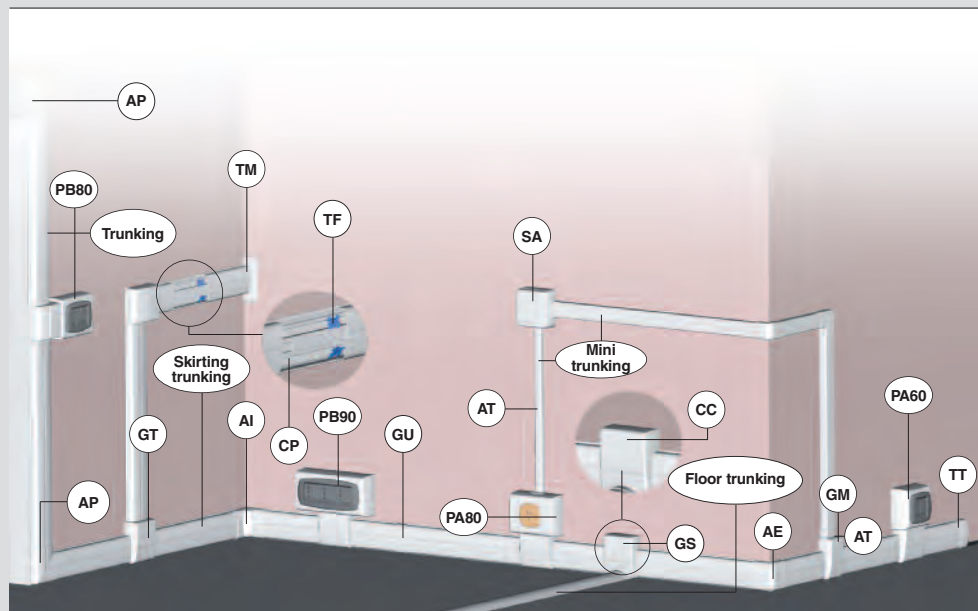

120mm VERSION

Offering excellent aesthetic and functional integration with skirting version 120 mm and with mini-trunking by Scame, WADO series.

KEY

- | | |
|---|---|
| AP - Flat angle | GS - Floor trunking joint |
| AI - Variable internal angle | TT - End cap |
| AE - Variable external angle | TF - Cable retainer |
| CC - Closing cap | TM - Wall passage terminal |
| GT - Flat tees | PA - Box for switches or sockets |
| GU - Joint cover | PB - Box for switches or sockets |
| GM - Flat tees for mini-trunking | AT - End adaptor (mini-trunking) |
| GT - Flat tees | |

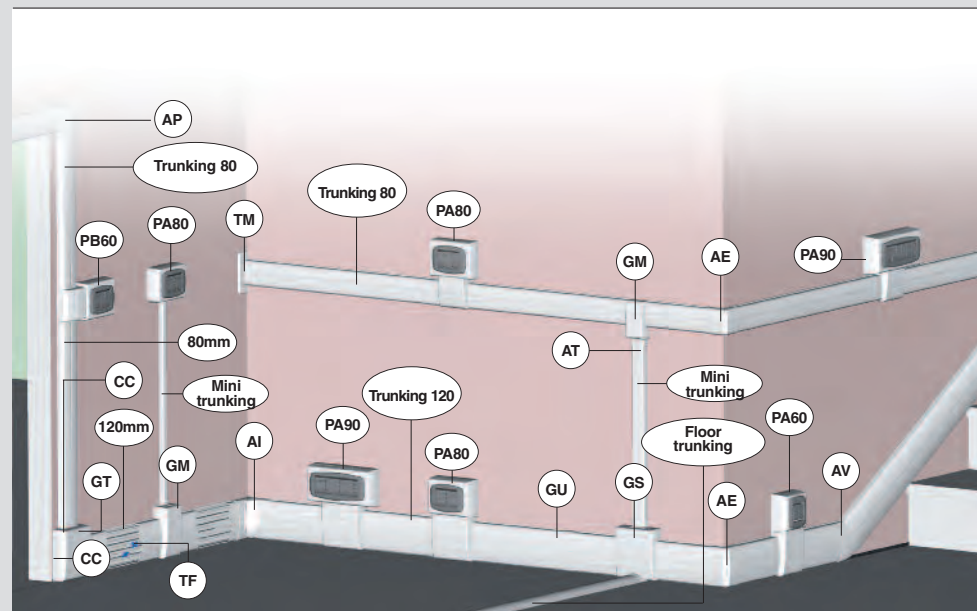

WADO Series - Cable trunking

■ CABLE AND SET HOUSING TRUNKING

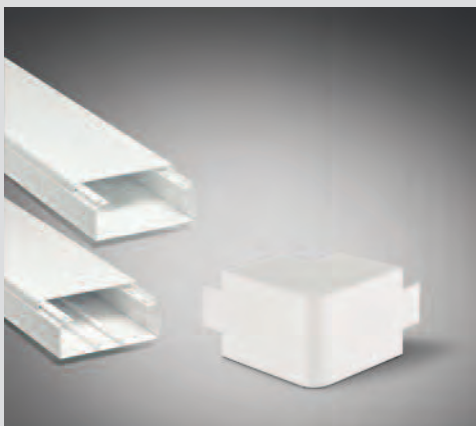

■ VERSIONS

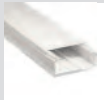
	Cable trunking
	Cable and set housing trunking

■ REFERENCE STANDARD

CEI 23-32
Trunking insulating plastic material and related accessories for cable trunking and carrying electrical appliances, for ceiling and wall-mounting.

■ QUALITY MARKS



■ TECHNICAL CHARACTERISTICS

Protection degree:	IP40
Operating ambient temperature according to the reference standard:	-25°C +60°C
Max. operating ambient temperature:	60°C
Glow Wire test:	960°C
Material:	Engineering plastic
Colour:	White RAL 9016
Impact resistance according to the reference standard:	6 Joule

■ BEHAVIOUR WITH CHEMICAL AND ATMOSPHERIC AGENTS

Saline solution	Acids		Bases		Solvents				Mineral oil	UV rays
	Concentrated	Diluted	Concentrated	Diluted	Hexane	Benzol	Acetone	Alcohol		
Resistant	Limited Resistance	Resistant	Limited Resistance	Resistant	Not Resistant	Not Resistant	Limited Resistance	Resistant	Resistant	Resistant

■ TRUNKING SECTIONS AND NUMBER OF CABLES TO INSTALL

Type of trunking A	Type of trunking B	Trunking geometry separating cm ²	SEZ.	SEZ.	SEZ.	SEZ.	SEZ.	SEZ.	SEZ.
			1,5mm ²	2,5mm ²	4mm ²	6mm ²	10mm ²	16mm ²	25mm ²
40	40	14,2	74	51	39	23	16	12	7
60	40	20,4	105	74	56	33	23	17	11
60	60	32	166	115	88	51	35	26	17
80	60	42,4	220	153	117	68	47	35	22
100	60	53,6	279	194	148	86	59	44	28
150	60	79,5	413	287	220	128	88	65	42
100	80	72,8	379	263	201	117	80	60	38
150	80	108,8	566	393	301	175	120	89	57
200	80	149,7	758	526	403	234	161	120	77

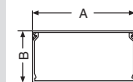

■ WORKING GEOMETRIC SECTION OF TRUNKING IN cm² WITH INSTALLED SWITCH HOLDERS

Type of trunking A	Trunking section B	Holder centre distance cm ²	Holder centre distance 83,5cm ²	Jack holder 60cm ²	Socket holder cm ²	cm ²
80	60	42,6	8	7	0,3	-
100	60	53,6	19	18	11	-
120	60	62,9	28	27	21	-
150	60	79,5	45	44	37	-
100	80	72,8	38	37	31	-
150	80	108,8	74	73	66	27
200	80	145,7	111	110	103	64

WADO Series - Slotted cable trunking

■ SLOTTED CABLE TRUNKING

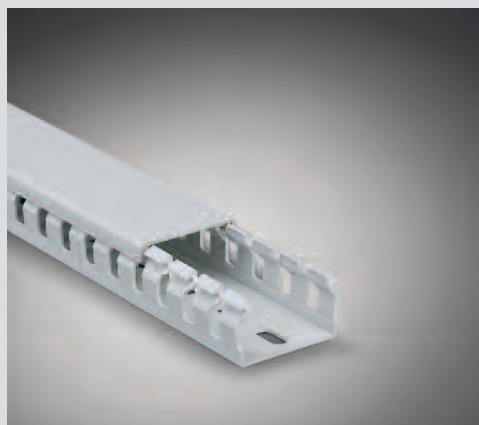

■ VERSIONS



Slotted cable trunking
- standard pitch
- short pitch

■ REFERENCE STANDARDS

EN 50085-1

Cable trunking systems and cable ducting systems for electrical installations.
Parte 1: general requirements.

EN 50085-2-3

Cable trunking systems and cable ducting systems for electrical installations.
Part 2-3: particular requirements for slotted cable trunking systems intended for installation in cabinets.

■ QUALITY MARKS



■ TECHNICAL CHARACTERISTICS

Operating ambient temperature according to the reference standard: **-5°C +60°C**

Max. operating ambient temperature: **60°C**

Glow Wire test: **960°C**

Material: **Engineering plastic**

Colour: **Grey RAL 7030**

Impact resistance according to the reference standard: **1 Joule**

■ BEHAVIOUR WITH CHEMICAL AND ATMOSPHERIC AGENTS

Saline solution	Acids		Bases		Solvents				Mineral oil	UV rays
	Concentrated	Diluted	Concentrated	Diluted	Hexane	Benzol	Acetone	Alcohol		
Resistant	Limited Resistance	Resistant	Limited Resistance	Resistant	Not Resistant	Not Resistant	Limited Resistance	Resistant	Resistant	Resistant

■ APPLICATION EXAMPLES



WADO Series - Trunking for air conditioning systems

TRUNKING FOR AIR CONDITIONING SYSTEMS



VERSIONS

	Dimension: 60x45mm
	Dimension: 80x60mm
	Dimension: 110x75mm

TECHNICAL CHARACTERISTICS

Operating ambient temperature according to the reference standard:	-25°C +60°C
Material:	Engineering plastic
Colour:	White RAL 9001

TECHNICAL CHARACTERISTICS OF THE MATERIAL

Resistance to tensile stress:	40N/mm²
Resistance to breaking:	38N/mm²
Elongation to pulling stress:	109%
Elastic module:	2810N/mm²
Resistance to impacts 23°C c.i.:	745/m
Vic at softening temperature 50N (thermal increment 50°C/h):	81°C
Inflammability on 1.36 mm thickness (flame is not propagated):	UL 94 V-0

BEHAVIOUR WITH CHEMICAL AND ATMOSPHERIC AGENTS

Saline solution	Acids		Bases		Solvents				Mineral oil	UV rays
	Concentrated	Diluted	Concentrated	Diluted	Hexane	Benzol	Acetone	Alcohol		
Resistant	Limited Resistance	Resistant	Limited Resistance	Resistant	Not Resistant	Not Resistant	Limited Resistance	Resistant	Resistant	Resistant

FIXING HOLES

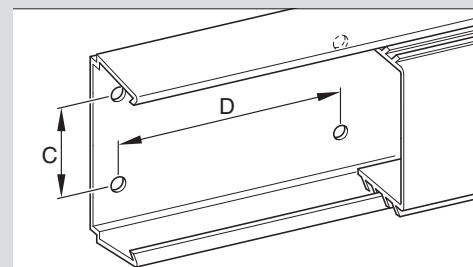

Code	C	D
871.060	35	200
871.080	50	200
871.110	80	200

METHOD OF INSTALLATION

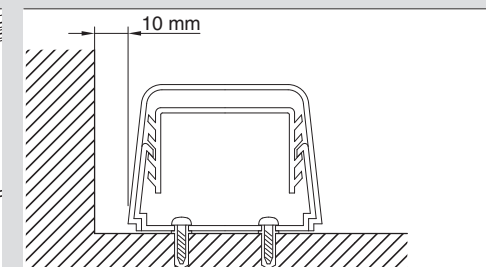

The trunking base is pre-drilled at 600mm centres for wall fixing. The bracket has to be installed just on blocks. The bend and wall passage are ready for fixing by blocks.

APPLICATION EXAMPLES

