

**PIATTELLO DI RICAMBIO 450 (2P+T) - SOCKET-HOLDER DISC 450 (2P+E)**  
**DISCO DE REPUESTO 450 (2P+T) - PLATINE DE RECHANGE 450 (2P+T)**

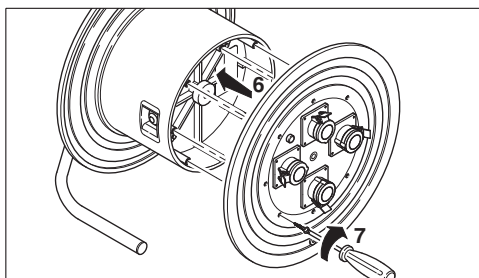
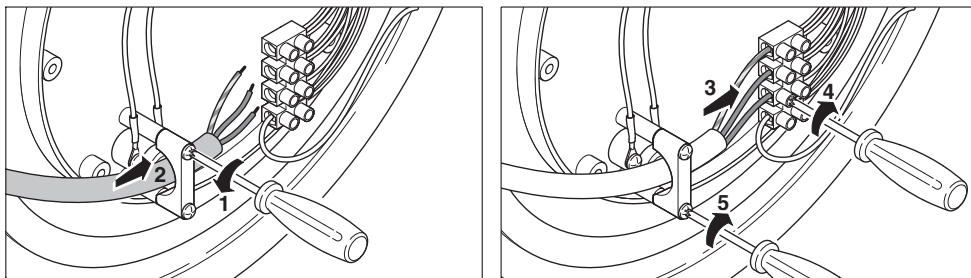

Coppia di chiusura (Nm) - Torque (Nm)  
 Momento de torsion (Nm) - Couple de serrage (Nm)

Fermacavo - Cable clamp Sujetacable - Serre-câble	0,5
Morsetti - Terminals Bornes - Bornes	0,8
Piatello di ricambio - Socket-holder disc - Disco de repuesto - Platine de rechange	0,8

**PIATTELLO DI RICAMBIO 450 (3P+T - 3P+N+T) - SOCKET-HOLDER DISC 450 (3P+E - 3P+N+E)**  
**DISCO DE REPUESTO 450 (3P+T - 3P+N+T) - PLATINE DE RECHANGE 450 (3P+T - 3P+N+T)**

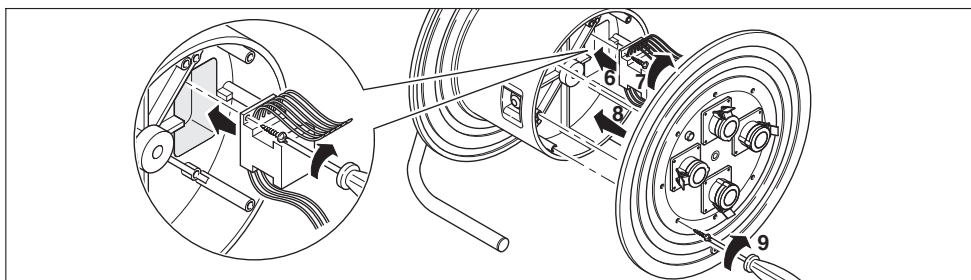
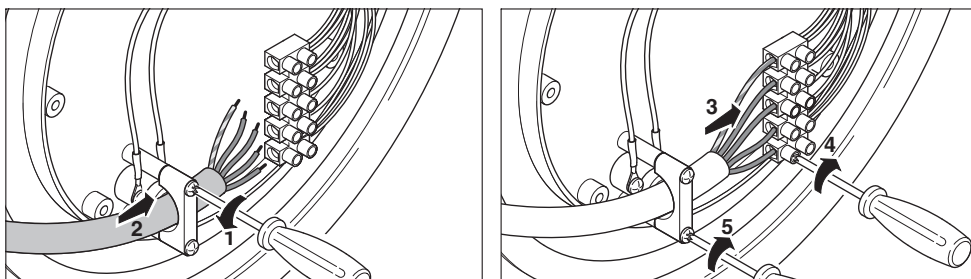

**InfoTECH**

ITALY

WORLDWIDE

Numero Verde  
**800-018009**

ScameOnLine  
 www.scame.com  
 infotech@scame.com

746.0000-000

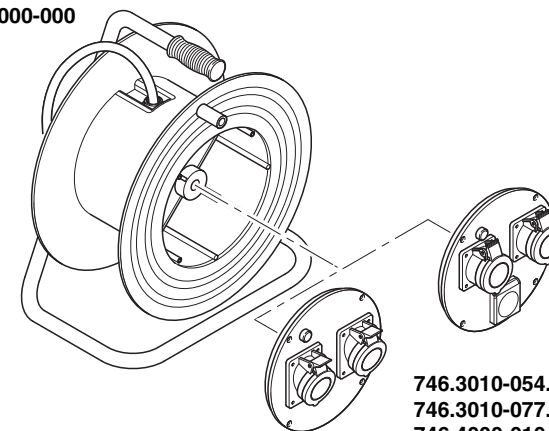

746.3010-054.P  
 746.3010-077.P  
 746.4000-010.P  
 746.3510-077.P  
 746.3000-010.P  
 746.4000-385.P  
 746.3000-385.P  
 746.3010-056.P  
 746.3510-091.P  
 746.2010-052.P

- La sostituzione del piatello deve essere eseguita da personale specializzato
- Quando viene sostituito il relativo piatello, l'avvolgicavo non deve essere collegato alla rete elettrica.
- The socket-holder disc must be replaced by skilled personnel only.
- When the relative socket-holder disc is replaced, the cable reel must be unplugged from the mains.

- El disco debe ser sustituido por personal especializado
- Cuando se sustituye el disco, no conectar el enrollacables a la red eléctrica.
- La platine doit être remplacée par du personnel spécialisé
- Pendant le remplacement de la platine, l'enrouleur de câble doit se trouver hors tension

**PIATTELLO DI RICAMBIO 330 (2P+T) - SOCKET-HOLDER DISC 330 (2P+E)**  
**DISCO DE REPUESTO 330 (2P+T) - PLATINE DE RECHANGE 330 (2P+T)**

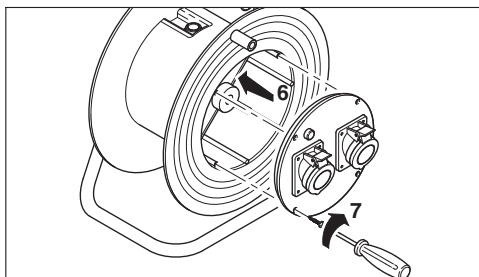
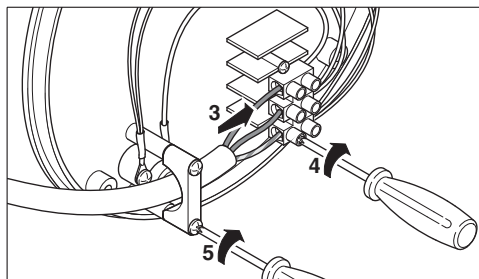
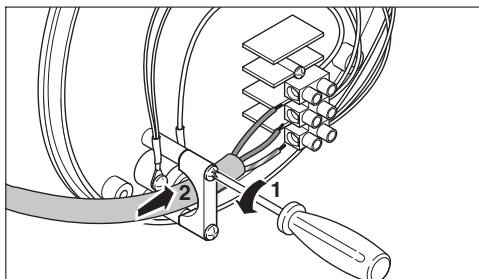

Coppia di chiusura (Nm) - Torque (Nm)	
Momento de torsion (Nm) - Couple de serrage (Nm)	
Fermacavo - Cable clamp	0,5
Sujetacable - Serre-câble	
Morsetti - Terminals	0,8
Bornes - Bornes	
Piattello di ricambio - Socket-holder disc - Disco de repuesto - Platine de rechange	0,8

**PIATTELLO DI RICAMBIO 330 (3P+T - 3P+N+T) - SOCKET-HOLDER DISC 330 (3P+E - 3P+N+E)**  
**DISCO DE REPUESTO 330 (3P+T - 3P+N+T) - PLATINE DE RECHANGE 330 (3P+T - 3P+N+T)**

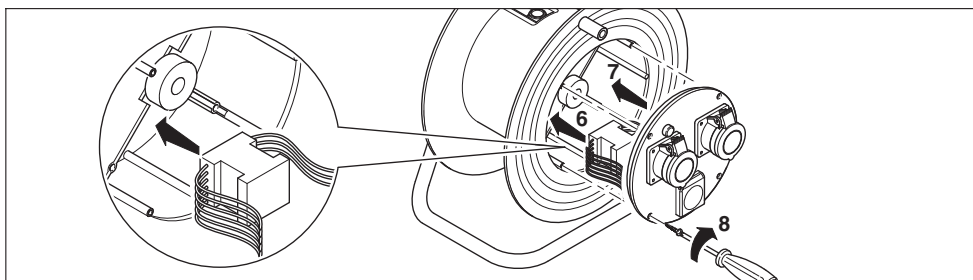
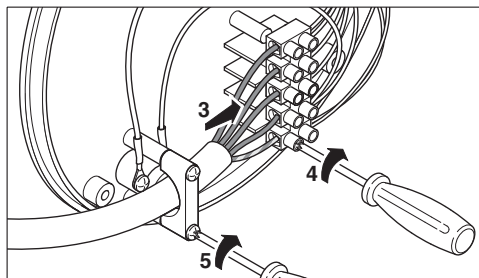
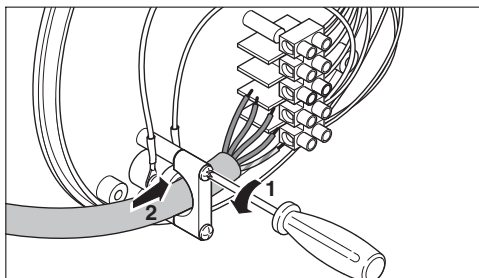

**745.0000-000**

**745.5505-012.P**  
**745.3505-012.P**  
**745.5505-006.P**

- La sostituzione del piattello deve essere eseguita da personale specializzato
- Quando viene sostituito il relativo piattello, l'avvolgicavo non deve essere collegato alla rete elettrica.
- El disco debe ser sustituido por personal especializado
- Cuando se sustituye el disco, no conectar el enrollacables a la red eléctrica.
- The socket-holder disc must be replaced by skilled personnel only.
- When the relative socket-holder disc is replaced, the cable reel must be unplugged from the mains.
- La platine doit être remplacée par du personnel spécialisé
- Pendant le remplacement de la platine, l'enrouleur de câble doit se trouver hors tension