



TO ALL OUR CUSTOMERS

NEW 1. **SWITCHES: DRIVE EXTENSIONS FOR DOOR INTERLOCK**

The SCAME product line has been extended regarding door interlock drive extensions.

In addition to the 185mm and 300mm versions already present in the catalogue, now new 85mm versions have been added that, like the present versions, will be available for Type "B" (Box) switches with dimensions 5x5mm for 16A, 32A and 40A modules, and dimensions 6x6mm for 63A and 80A modules.



The following new catalogue numbers have thus been created:

DRIVE EXTENSION FOR DOOR INTERLOCK

DESCRIPTION	FOR SWITCHES	LENGTH	DIMENSIONS	PACKAGE BULK PACK	CATALOGUE NUMBER
For Box modules	16A - 32A - 40A	85mm	5x5mm	10	590.YMA085
	63A - 80A	85mm	6x6mm	10	590.YMB085



NEW 2. **SWITCHES: SWITCH DISCONNECTORS MANAGEMENT**

Management of the switch disconnectors has been modified along with the relative front switching panels. The switches will be supplied complete with brackets, bushings and relative screws (and, for Type "R" modules, the shaft), while the front controls will be supplied without the components already assembled on the switch and without drives extension. Thus for the Type "B" modules, in order to complete the purchase, the customer will have to purchase the drive extension separately (previously the 85mm drive extension was supplied as standard).

Essentially:

- For Type "B" modules the drive extension has been taken out from the front control so that the customer can select the drive extension with the most suitable length for the particular application;
- For Type "B" and Type "R" modules, brackets, bushings and relative screws (and the shaft for Type "R" modules), that were previously supplied with the front control, are now supplied already assembled on the switch.

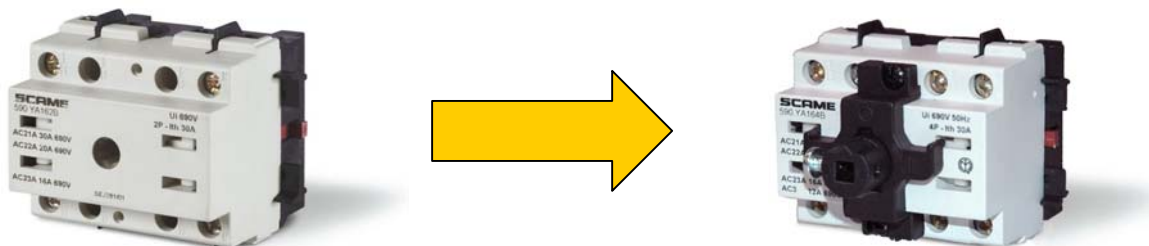

Example of switch disconnecter 16A - 32A – 40A Type “B” module

Attention: the catalogue numbers remain unchanged.

Products concerned by the change:

SWITCHES - DISCONNECTORS

DESCRIPTION	THERMAL CURRENT	PACKAGE BULK PACK	Type “R”	Type “B”	
			Backpanel	Box	
			CATALOGUE NUMBER	CATALOGUE NUMBER	
16A	2P	30A	1/6	590.YA162R	590.YA162B
	3P	30A	1/6	590.YA163R	590.YA163B
	4P	30A	1/6	590.YA164R	590.YA164B
32A	2P	40A	1/6	590.YA322R	590.YA322B
	3P	40A	1/6	590.YA323R	590.YA323B
	4P	40A	1/6	590.YA324R	590.YA324B
40A	2P	40A	1/6	590.YA402R	590.YA402B
	3P	40A	1/6	590.YA403R	590.YA403B
	4P	40A	1/6	590.YA404R	590.YA404B
63A	2P	63A	1/6	590.YA632R	590.YA632B
	3P	63A	1/6	590.YA633R	590.YA633B
	4P	63A	1/6	590.YA634R	590.YA634B
80A	2P	86A	1/6	590.YA802R	590.YA802B
	3P	86A	1/6	590.YA803R	590.YA803B
	4P	86A	1/6	590.YA804R	590.YA804B

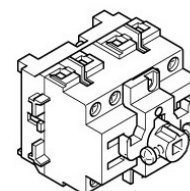

16A-32A-40A Type “B”

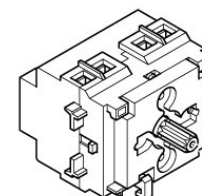

16A-32A-40A Type “R”

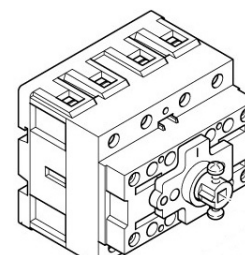

63A-80A Type “B”

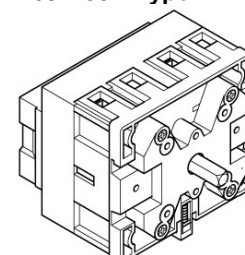







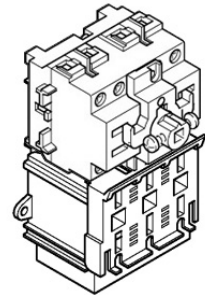











SWITCHES – DISCONNECTORS WITH FUSE HOLDER

DESCRIPTION	THERMAL CURRENT	PACKAGE BULK PACK	Type "B" Box	
			CATALOGUE NUMBER	
16A	2P	30A	1/6	590.YF162B
	3P	30A	1/6	590.YF163B
	4P	30A	1/6	590.YF164B
32A	2P	40A	1/6	590.YF322B
	3P	40A	1/6	590.YF323B
	4P	40A	1/6	590.YF324B



16A-32A-40A Type "R" with fuse holder







67X67mm FRONT CONTROLS

DESCRIPTION	FOR SWITCHES	KNOB	FACING	PACKAGE BULK PACK	CATALOGUE NUMBER	
					Passth. fitting	Fitting Ø 22
for R type	16A, 32A and 40A			1/10	590.YM67R1	590.YM68R1
				1/10	590.YM67R2	590.YM68R2
for B type	16A, 32A and 40A			1/10	590.YM67B1	590.YM68B1
				1/10	590.YM67B2	590.YM68B2
for R type s	63A and 80A			1/10	590.YM67R6	-
				1/10	590.YM67R7	-
for B type	63A and 80A			1/10	590.YM67B6	590.YM68B6
				1/10	590.YM67B7	590.YM68B7

 67

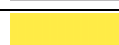

48X48mm FRONT CONTROLS









DESCRIPTION	FOR SWITCHES	KNOB	FACING	PACKAGE BULK PACK	CATALOGUE NUMBER	
					Passth. fitting	Fitting Ø 22
for R type	16A, 32A and 40A			1/10	590.YM48R1	590.YM50R1
				1/10	590.YM48R2	590.YM50R2
for B type	16A, 32A and 40A			1/10	590.YM48B1	590.YM50B1
				1/10	590.YM48B2	590.YM50B2

 48





LOCKABLE 48X48mm FRONT CONTROLS

DESCRIPTION	FOR SWITCHES	KNOB	FACING	PACKAGE BULK PACK	CATALOGUE NUMBER	
					Passtr. fitting	Fitting Ø 22
for R type	16A, 32A and 40A			1/10	590.YM49R1	590.YM51R1
				1/10	590.YM49R2	590.YM51R2
for B type	16A, 32A and 40A			1/10	590.YM49B1	590.YM51B1
				1/10	590.YM49B2	590.YM51B2

 **48**



SWITCHES TYPE "R"

16A - 40A Ø 22 fitting

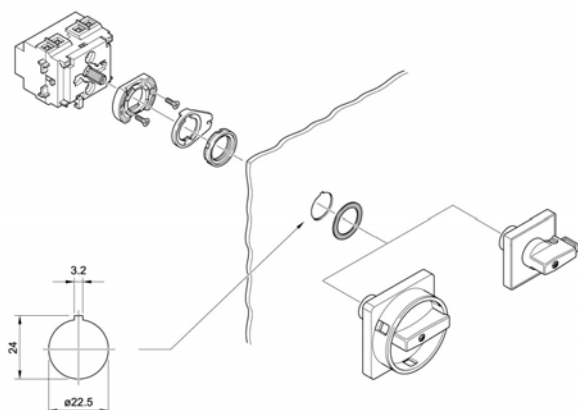

16A - 40A passthrough fitting

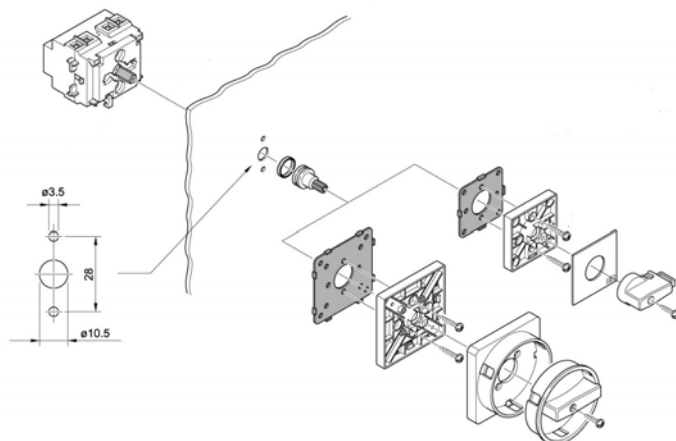

63A - 80A passthrough fitting

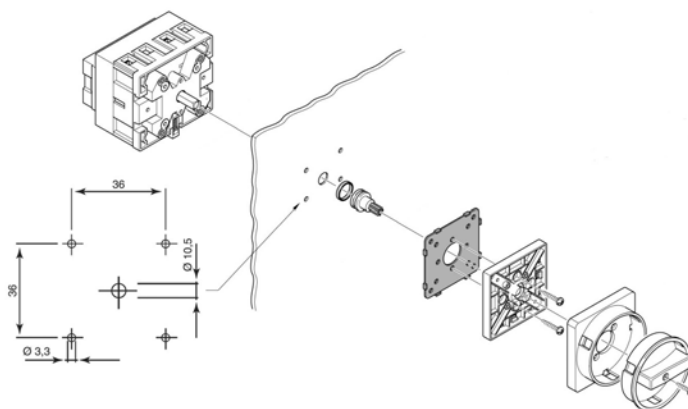



SWITCHES TYPE "B"

16A - 40A Ø 22 fitting

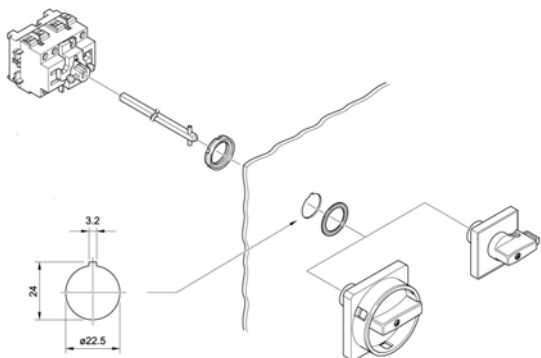

16 - 40A passthrough fitting

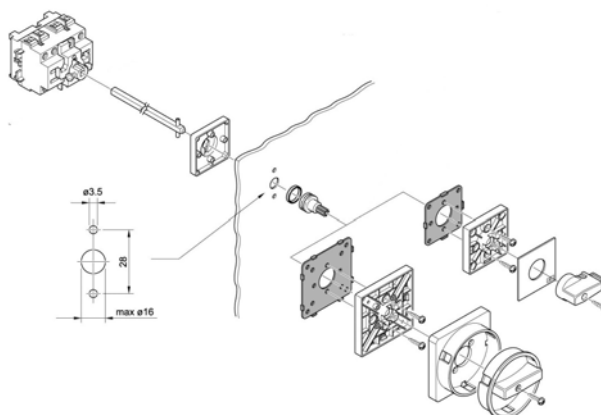

63A - 80A Ø 22 fitting

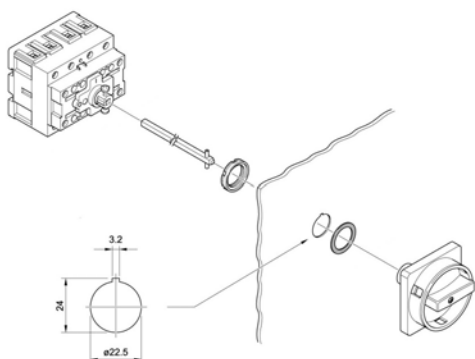

63A - 80A passthrough fitting

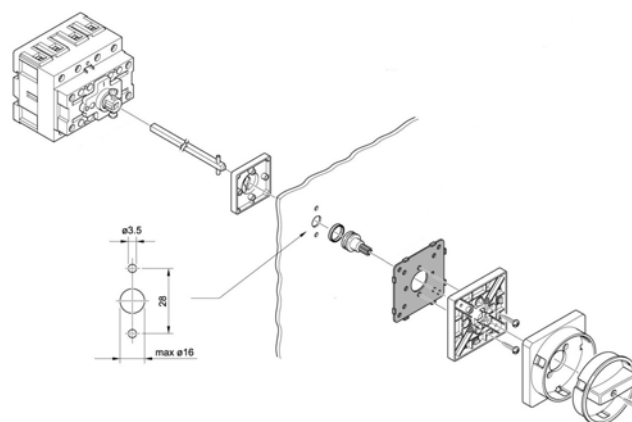

Example of catalogue numbers to order for 16A 4P switch-disconnector

Fastening of box with 67 x 67 mm front emergency control and 22mm diameter fitting.

590.YA164B + 590.YMA085 + 590.YM68R1



NEW

3. EVOLUTION SERIES PLATES: COLOURS

The **Exclusive** series of the Bombèe and Classic lines has been divided into two subgroups:

- **Nature** (veneer and wood)
- **Tech** (metal)

Thus a remarkably enhanced range of plates is now available to those looking for exclusive units with innovative elements.

The common starting point of all the new versions is the engineering polymer with which they are made, but they differ in terms of the subsequent working process:

- .XCS for chrome plating (metal layer deposit)
- .XNL for nickel plating (metal layer deposit) and subsequent surface brushing
- .XNO for nickel plating, brushing and final transparent painting.
- .XCB; .XFR; XGS are produced by cubicature (deposit of water-soluble film plus painting)
- .XNS is produced by painting

The working process which the first three codes undergo provides the finished product with excellent structural qualities similar to those of metal plates.

CLASSIC Line		3 MODULES		4 MODULES		6 MODULES	
Key	FINISH	Pack./ Bulk Pk	Catalogue N.	Pack./ Bulk Pk	Catalogue N.	Pack./ Bulk Pk	Catalogue N.
XCS	Satin-finished chrome	40	101.7013.XCS	40	101.7014.XCS	25	101.7016.XCS
XNL	Bright brushed nickel	40	101.7013.XNL	40	101.7014.XNL	25	101.7016.XNL
XNO	Opaque brushed nickel	40	101.7013.XNO	40	101.7014.XNO	25	101.7016.XNO
XCB	Carbon	40	101.7013.XCB	40	101.7014.XCB	25	101.7016.XCB
XGS	Brushed graphite	40	101.7013.XGS	40	101.7014.XGS	25	101.7016.XGS
XFR	Ash	40	101.7013.XFR	40	101.7014.XFR	25	101.7016.XFR
XNS	Satin-finished nickel	40	101.7013.XNS	40	101.7014.XNS	25	101.7016.XNS

BOMBEE Line		3 MODULES		4 MODULES		6 MODULES	
Key	FINISH	Pack./ Bulk Pk	Catalogue N.	Pack./ Bulk Pk	Catalogue N.	Pack./ Bulk Pk	Catalogue N.
XCS	Satin-finished chrome	50	101.9023.XCS	40	101.9024.XCS	25	101.9026.XCS
XNL	Bright brushed nickel	50	101.9023.XNL	40	101.9024.XNL	25	101.9026.XNL
XNO	Opaque brushed nickel	50	101.9023.XNO	40	101.9024.XNO	25	101.9026.XNO
XCB	Carbon	50	101.9023.XCB	40	101.9024.XCB	25	101.9026.XCB
XGS	Brushed graphite	50	101.9023.XGS	40	101.9024.XGS	25	101.9026.XGS
XFR	Ash	50	101.9023.XFR	40	101.9024.XFR	25	101.9026.XFR
XNS	Satin-finished nickel	50	101.9023.XNS	40	101.9024.XNS	25	101.9026.XNS





The **Bright** series of the Classic and Bombèe lines has been divided into two subgroups:

- **Elegance** (current colours .AT; .AV; .B; .N)
- **Smile** (current colours .AZ; .BL; .GL; .R)

The Smile series is expanded with four new pastel shades **.AC; .VA; .GS; .RS**

All the plates are made of engineering polymer.

The Smile series, characterized by bright colours and new pastel shades, is particularly indicated for realizations such as preschools or schools which, in addition to an attractive final appearance, also require greater cost effectiveness.

CLASSIC Line		3 MODULES		4 MODULES		6 MODULES	
Key	BRIGHT FINISH	Pack./ Bulk Pk	Catalogue N.	Pack./ Bulk Pk	Catalogue N.	Pack./ Bulk Pk	Catalogue N.
AC	SMILE – Sky blue	40	101.7013.AC	40	101.7014.AC	25	101.7016.AC
VA	SMILE – Sea green	40	101.7013.VA	40	101.7014.VA	25	101.7016.VA
GS	SMILE – Sunny yellow	40	101.7013.GS	40	101.7014.GS	25	101.7016.GS
RS	SMILE - Pink	40	101.7013.RS	40	101.7014.RS	25	101.7016.RS



BOMBEE Line		3 MODULES		4 MODULES		6 MODULES	
Key	BRIGHT FINISH	Pack./ Bulk Pk	Catalogue N.	Pack./ Bulk Pk	Catalogue N.	Pack./ Bulk Pk	Catalogue N.
AC	SMILE – Sky blue	50	101.9023.AC	40	101.9024.AC	25	101.9026.AC
VA	SMILE – Sea green	50	101.9023.VA	40	101.9024.VA	25	101.9026.VA
GS	SMILE – Sunny yellow	50	101.9023.GS	40	101.9024.GS	25	101.9026.GS
RS	SMILE - Pink	50	101.9023.RS	40	101.9024.RS	25	101.9026.RS

OUT OF PRODUCTION

4. **EVOLUTION SERIES PLATES: 5 COLOURS**

CLASSIC LINE PLATES

VELVET finish		
BLUE	3 modules	101.7013.YBL
BLUE	4 modules	101.7014.YBL
BLUE	6 modules	101.7016.YBL
GREEN	3 modules	101.7013.YV
GREEN	4 modules	101.7014.YV
GREEN	6 modules	101.7016.YV

BOMBEE LINE PLATES

VELVET finish		
BLUE	3 modules	101.9023.YBL
BLUE	4 modules	101.9024.YBL
BLUE	6 modules	101.9026.YBL
GREEN	3 modules	101.9023.YV
GREEN	4 modules	101.9024.YV
GREEN	6 modules	101.9026.YV



GUMMED finish			GUMMED finish		
ANTHRACITE	3 modules	101.7013.ZAT	ANTHRACITE	3 modules	101.9023.ZAT
ANTHRACITE	4 modules	101.7014.ZAT	ANTHRACITE	4 modules	101.9024.ZAT
ANTHRACITE	6 modules	101.7016.ZAT	ANTHRACITE	6 modules	101.9026.ZAT
IVORY	3 modules	101.7013.ZAV	IVORY	3 modules	101.9023.ZAV
IVORY	4 modules	101.7014.ZAV	IVORY	4 modules	101.9024.ZAV
IVORY	6 modules	101.7016.ZAV	IVORY	6 modules	101.9026.ZAV
BLACK	3 modules	101.7013.ZN	BLACK	3 modules	101.9023.ZN
BLACK	4 modules	101.7014.ZN	BLACK	4 modules	101.9024.ZN
BLACK	6 modules	101.7016.ZN	BLACK	6 modules	101.9026.ZN

SCAME PARRE S.p.A.
MARKETING OFFICE