

TO ALL OUR CUSTOMERS

1. NEW PRODUCTS, SCABOX SERIES JUNCTION BOXES

The offer of SCABOX Series junction boxes is extended. A new junction box made of thermoplastic material is added to the series of products. The new junction box will be available in the following versions:

- Low block with cable sleeve, blind cover (size 460x380x130mm), 14 PG36 cable sleeves;
- Low blank-side, blind cover (size 460x380x130mm);
- High blank-side, blind cover (size 460x380x130mm);
- Low blank-side, transparent cover (size 460x380x130mm);
- Low blank-side, transparent cover (size 460x380x130mm);

Features are consistent with the rest of SCABOX Series products. The protection degree is IP55 for versions provided with cable sleeve and IP56 for blank-side versions.

Boxes are also equipped with the related base plate of zinc-plated steel and the wall mounting brackets kit.

The rest of accessories remains the same as for the other sizes: screw covers for complete insulation, lead plating kit, flap kit.

Description	Cover	Dimension	Catalogue Number
Low block with cable sleeve – IP55	Blind	460x380x130mm	685.011
Low blank-side – IP56	Blind	460x380x130mm	686.211
Low blank-side – IP56	Transparent	460x380x130mm	686.231
High blank-side – IP56	Blind	460x380x180mm	686.411
High blank-side – IP56	Transparent	460x380x180mm	686.431

Mounting Plate	654.0791
Wall mounting brackets kit for SCABOX 460x380mm	654.0023

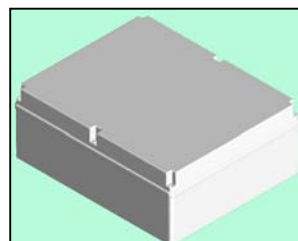
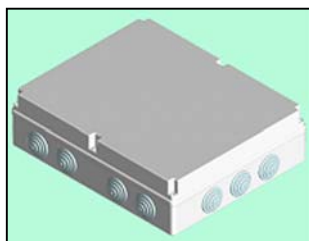

2. NEW PRODUCTS, SWITCHES FOR ARGENTINA STANDARD SOCKETS OF THE EVOLUTION SERIES:

The offer of components for the EVOLUTION Series has been now implemented. A new switch has been designed for Argentina standard 2P+E 10A 250V~ (IRAM). The new socket takes one gang (size 23mm) and is perfectly modular to the whole EVOLUTION series, UNIBOX series boxes and 570.5052 IP55 flange 70x87mm flap covers, which facilitates the fixing of home sockets to BLOCK and DOMINO series SCAME enclosures.

The new products is coded according to the 3 colour-models: white, grey and anthracite.

Description	Catalogue Number
Argentina socket 2P+E 10A 250V~ - anthracite	101.6425
Argentina socket 2P+E 10A 250V~ - white	101.6425.B
Argentina socket 2P+E 10A 250V~ - gray	101.6425.G



EVOLUTION Series

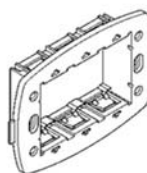

UNIBOX Series

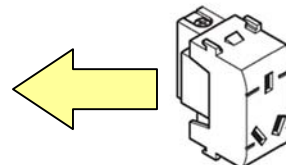
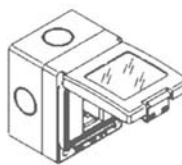

BLOCK & DOMINO Series

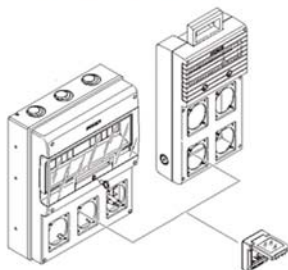

Catalogue Number 570.5052

3. NEW 40A SWITCH - DISCONNECTING SWITCH

The range of power disconnecting switches is now implemented by introducing the 40A version for both box and back-of-board performances.

The electric features of disconnecting switches are as follows:

- Insulating rated voltage **Ui: 690 (Vac) and 400 (Vdc)**
- Pulse voltage rated resistance **Uimp: 4 (kV)**
- Thermal rated voltage **Ith: 40 (A)**
- Thermal rated voltage **Ithe: 40 (A)**
- Working rated voltage **In AC21A (400V): 40 (A)**
- Working rated voltage **In AC22A (400V): 40 (A)**
- Working rated voltage **In AC23A (690V): 25 (A)**
- Working rated voltage **In AC3 (400V): 28,5 (A)**
- Working rated voltage **In AC3 (690V): 20 (A)**



Description	Performance	Poles	Catalogue Number
40A Operation / Disconnecting Switches	Box	2	590.YA402B
		3	590.YA403B
		4	590.YA404B
	Back-of-Board	2	590.YA402R
		3	590.YA403R
		4	590.YA404R

Accessories of the new connecting / disconnecting switches are the same as for 16A and 32A products.

We remember you that these accessories are available:

- Single connector box;
- Front operators 67x67 mm;
- Cover block extensions;
- Front operators 48x48 mm;
- Lockable front operators 48x48 mm.

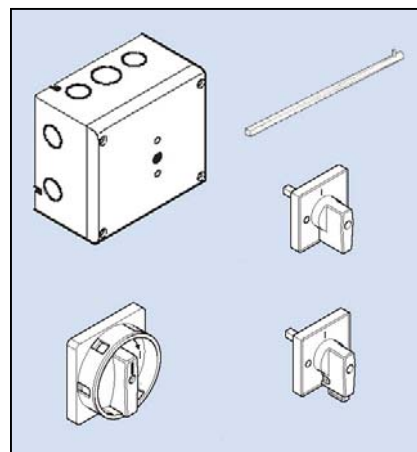



4. INFORMATION ABOUT THE "NEW PRODUCT CATALOGUE" PROJECT

We are renewing **ScameOnline** in its Product Catalogue section for the purpose of allowing people visiting our Website to get information and have updated and synchronized data.

The Product Catalogue will indeed use information directly taken from SCAME info management system.

This service will be available starting from early months of 2005.

Meanwhile we are at your disposal to examine or discuss about any of your suggestions on this matter.



We thank you for your attention and wish our Customers Merry Christmas and Happy New Year 2005.



SCAME PARRE SPA
EXPORT DEPT.