

TO ALL OUR CUSTOMERS

1. NEWS! A NEW BRANCH OF SCAME IN POLAND

SCAME reaches the horizon of Eastern Europe and opens a new commercial branch in Poland.

SCAME-POLSKA – this is the name of the new branch – it is located close to Kracovia and Katowice and will work in partnership with the existing subsidiaries that have already been operating for several years, and will contribute to the development of SCAME Group worldwide.

Complete address:

SCAME POLSKA
ul. Paderewskiego 69B
42400 Zawiercie - Poland
Tel. and fax 0048 32 6777217

2. NEW MINI-TRUNKING 40x20 WADO WITHOUT INTERNAL SECTIONS

WADO 's range of cable carrying mini-trunkings and accessories has been expanded. The 2-compartment 40x20mm mini-trunking, which is already in the catalogue, is now also available in the one-compartment version. Accessories are identical to the ones of the 2-compartment version.

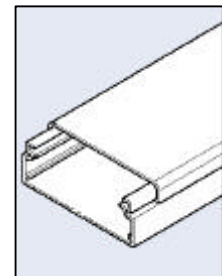

Description	Colour	Code
one-compartment mini-trunking	white	876.4021
40x20mm with STD cover	grey	876.4021G

3. NEW BOX FOR HOME ACCESSORIES UNIVEL

To complete the UNIVEL range, a new box for UNIVEL accessories for domestic applications has been created. This box grants an index of protection IP55 and can be installed in SCAME enclosures with a 70x87mm flange. This box is suitable for EVOLUTION and BASIC inserts.

Description	Code
Box for IP55 EVOLUTION & BASIC inserts	570.5052

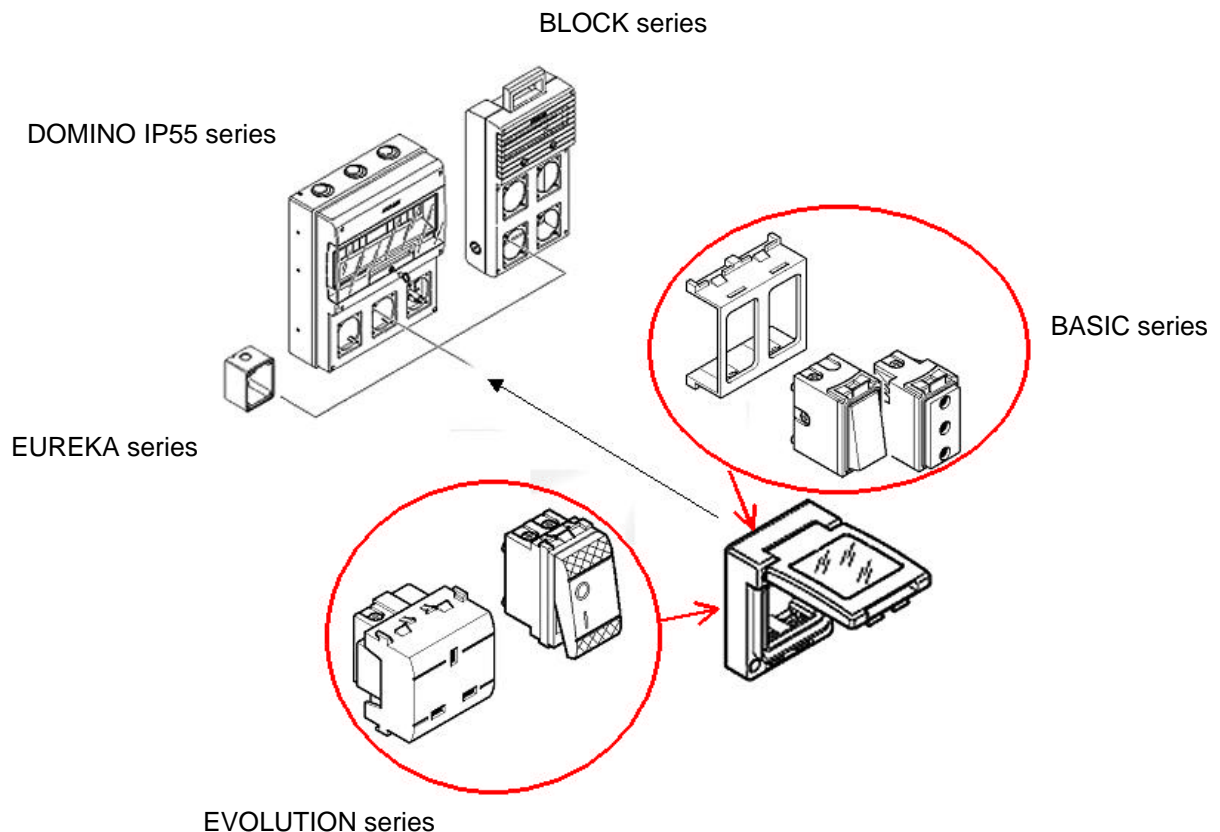
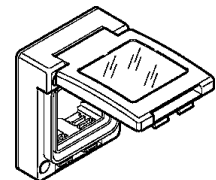

4. PRODUCT MODIFICATION : 90° FLUSH MOUNTING PLUGS AND SOCKETS

The 242, 247, 452 and 457 families of flush-mounting plugs and sockets have been redesigned.

These products are also suitable for wall-mounting installations.

A new version -the **3P+N+E 32A** version – has been added to the range of plugs and sockets.

Warning: codes are unchanged.

Previous Version
Flush mounting plugs 242 & 247 families
Flush mounting sockets 452 & 457 families

New Version
Wall-mounting plugs, 242 & 247 families. (codes are unchanged)
Wall-mounting sockets, 452 & 457 families (codes are unchanged)

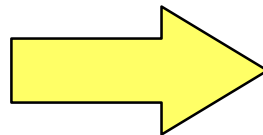
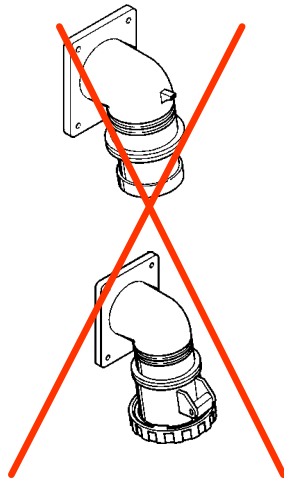

This new version offers two cabling possibilities : either from the flange side through knock-outs (flush mounting solution), or from the upper side (wall mounting solution).

5. OUT OF PRODUCTION: IEC309 FIXED PLUGS

Fixed wall-mounting plugs of the 240 and 245 families are now obsolete and consequently out of production. This article is replaced by EUREKA 242 and 247 family products.

OUT OF PRODUCTION

Fixed wall mounting plugs.
240 & 245 families - 16/32A

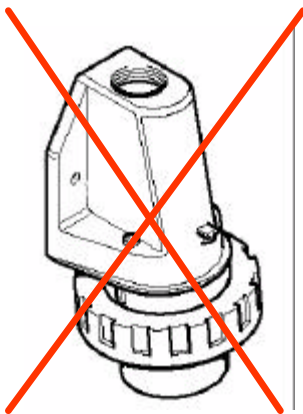

Replaced by

Wall-/flush mounting plugs.
242 & 247 families.



6. NEWS! LIDS FOR IP44 & IP67 PLUGS

Lids for IEC309 industrial plugs 2P+E 16A are now manufactured. The product protects plugs against mud and water jets. This lid is suitable for IP44 & IP67 plugs.

Description	Code
Lid for plugs - 16A, rated voltage >50V, 2P+E IP44 & IP67	570.0316



7. OUT OF PRODUCTION: FIXED WALL MOUNTING PLUGS WITH LID

Fixed wall mounting plugs IEC309 codes 240.1699 and 245.1699/S are almost sold out and, consequently, out of production. This product is now replaced by articles from the EUREKA series, 242 and 247 families provided with the corresponding lid code 570.0316.

Previous version	Replaced by
Fixed wall mounting plugs Code 240.1699	Wall / flush mounting plugs Code 242.1693 + 570.0316
Fixed wall mounting plugs Code 240.1699/S	Wall / flush mounting plugs Code 247.1693 + 570.0316

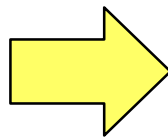
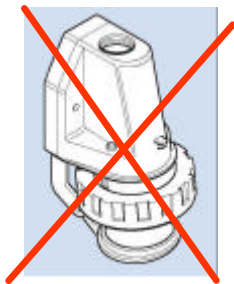

8. NEW FLUSH MOUNTING BOXES - WBOX SERIES

SCAME have now started producing new flush-mounting boxes for main and Secondary shunts for industrial, domestic and tertiary installations. With the WBOX series, SCAME also proposes a wide range of accessories and spare parts, such as screwless covers, mortar protections and dividers. Boxes are made of thermoplastic material. This range includes versions with possible inside dividers to be fixed in order to separate electrical circuits.

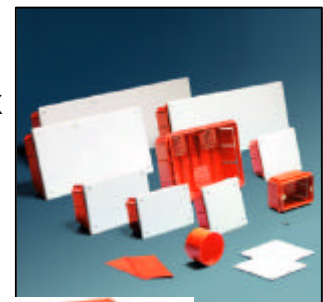

sections

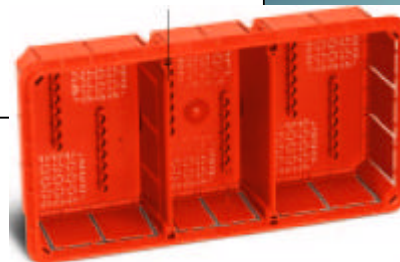

A brochure with all corresponding information is available in PDF format at this web page:

<http://www.scame.com/doc/ZP00559-GB-1.pdf> or in Spanish: <http://www.scame.com/doc/ZP00559-E-1.pdf>

Codes referring to the new boxes are specified below:

Description		Code
Flush mounting Box (provided with no cover and screws)	round, diameter 65 mm	875.4201
	rectangular 3 modules – Italian STD	875.4303
	rectangular 4 modules – Italian STD	875.4306
	rectangular 6 modules – Italian STD	875.4306
Flush mounting Box (provided with cover and screws)	92x92x45 mm	875.4410
	118x96x50 mm	875.4411
	153x98x50 mm	875.4412
	160x130x70 mm	875.4413
	196x152x70 mm – accepts separator 152	875.4414
	294x152x70 mm – accepts separator 152	875.4415
	392x152x70 mm – accepts separator 152	875.4416
480x160x70 mm – accepts separator 160	875.4417	
Divider	152 – height 152 mm	875.4490
	160 – height 160 mm	875.4491
20-screw pack	size 3x19mm	875.4500
Box covers	diam. 65 (with clamps)	875.4501
	diam. 80 (with clamps)	875.4502
	92x92x45 mm	875.4510
	118x96x50 mm	875.4511
	153x98x50 mm	875.4512
	160x130x70 mm	875.4513
	196x152x70 mm	875.4514
	294x152x70 mm	875.4515
	392x152x70	875.4516
480x160x70	875.4517	
Plastic protection cover against mortar	3 modules – Italian STD	875.4603
Protection covers against mortar in plastified cardboard	92x92x45 mm	875.4610
	118x96x50 mm	875.4611
	153x98x50 mm	875.4612
	160x130x70 mm	875.4613
	196x152x70 mm	875.4614
	294x152x70 mm	875.4615
	392x152x70	875.4616
480x160x70	875.4617	

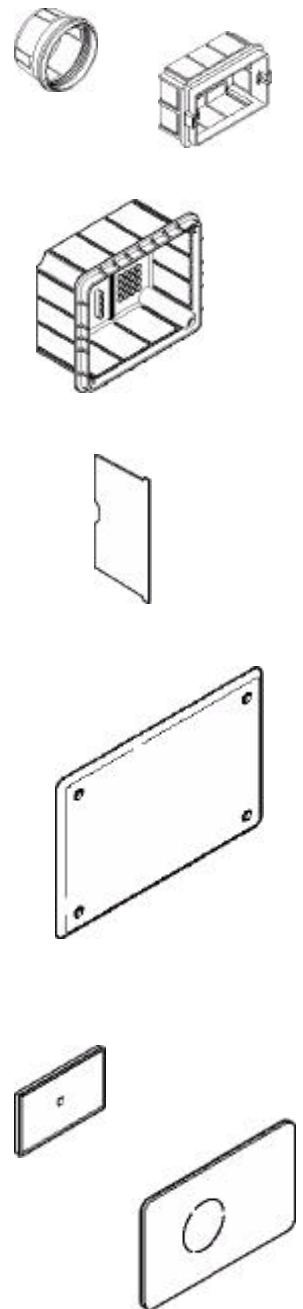

9. PRODUCT MODIFICATION: CHANGE IN THE COLOUR AND CODE OF BOX COVERS

After the creation of the WBOX series, colours and codes referring to covers for \varnothing 65 & 80mm boxes have been harmonised. The IVORY colour becomes WHITE. The modified codes are 135.35/60 and 135.35/80, but the technical characteristics of the product are unchanged.

The code of the flush mounting phone box 180.700 is also harmonised (Italian Standard).

Out of production
135.35/60 covers for \varnothing 65 boxes
135.35/80 covers for \varnothing 80 boxes
180.700 Recessed box for phones

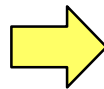

Replaced by
875.4501 Covers for \varnothing 65mm boxes
875.4502 Covers for \varnothing 80mm boxes
875.4301 Recessed box for phones

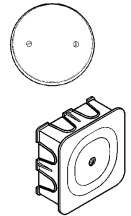

10. PRODUCT MODIFICATION : CHANGE IN DIMENSIONS OF ALUBOX

The dimensions of ALUBOX metal junctions boxes, 653 family, have been changed.

Designs and new dimensions of all modified articles are reported below.

Warning: codes are unchanged.

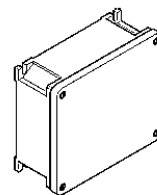
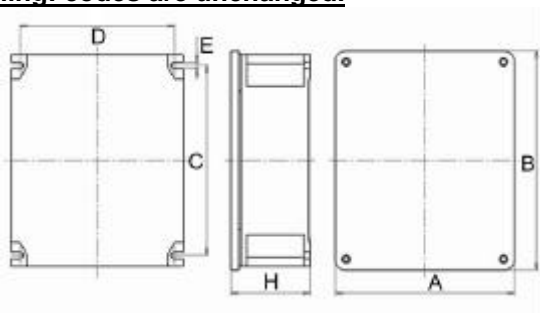

Code	A (mm)	B (mm)	H (mm)	C (mm)	D (mm)	E (mm)
653.03	169	193	80	168	149	6
653.04	218	254	92	226	196	9
653.05	264	315	122	275	236	9

The corresponding mounting plates (653.012, 653.013 and 653.014) are also concerned by the modifications.

The fixing holes have been adjusted to the new boxes.

SCAME PARRE SPA
EXPORT DEPT.