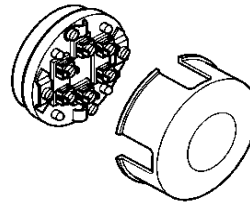

**TO ALL OUR CUSTOMERS**

We thank all of these who came to visit our stand at the INTEL fair 2001 of Milan .  
We inform you the modifications made to our production.

**PRODUCTS OUT OF PRODUCTION****TV and Telephone Series****Junction boxes for surface mounting**

-ART 180.163

**Coaxial cable socket outlet for surface mounting and coaxial cable socket outlet for flush mounting**

-ART 180.59/1 CEI

-ART 180.59/3 CEI

-ART 180.61 CEI

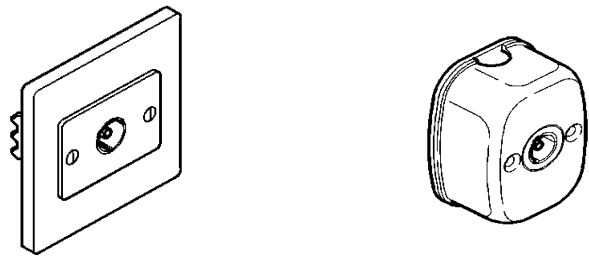
**IEC 309 SERIES Panel mounting sockets IP 44****Sockets for mounting on DIN rails –IP 44**

-ART 410.1663 DIN

-ART 410.1666 DIN

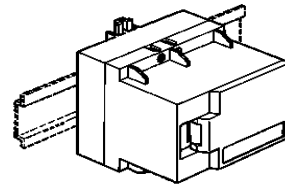

**Adaptors with protection devices**

-3-4 way adaptors for elevated installation

NOTE: ART 625 IP 44 are out of production but IP 66 remain in production.

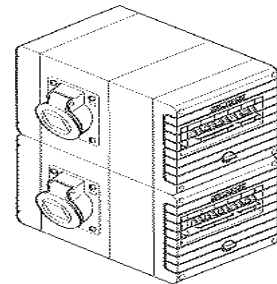
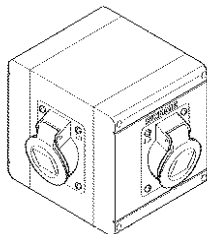

-3-4 way adaptors with cable and plug

-ART 621 IP 44 OR IP 66

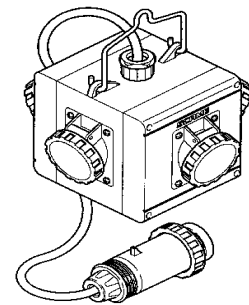
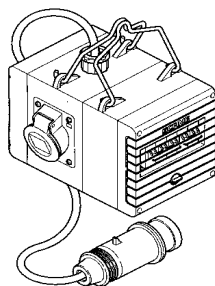

**Emergency versions light fitting for fixed installations**

-ART 792.12318

-ART 792.12318

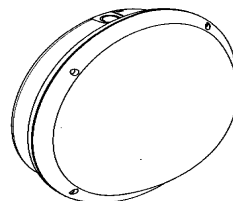

## PRODUCTS REPLACED

### Switchgear

Emergency stop with pushbutton release -IP 50 and with twist release -IP 65

- ART 590 SC 190 replaced by ART 590 PQ 01 R4S
- ART 590 SC 250 replaced by ART 590 PQ 01 R4N
- ART 590 SC 260 replaced by ART 590 PQ 01 C4N

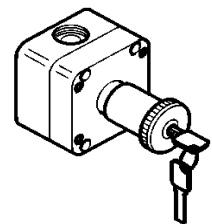
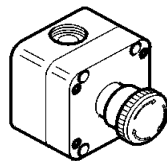
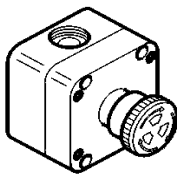
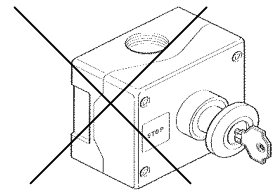
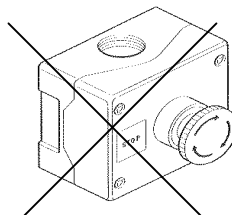
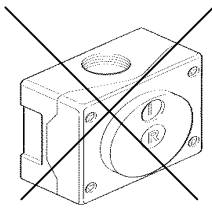

### IEC 309 SERIES accessories

Sockets for domestic application with panel mounting flange 70x87 mm-IP 44

- ART 570 4090 replaced by ART 570 4091
- ART 570 4070 replaced by ART 570 4071
- ART 570 4060 replaced by ART 570 4061

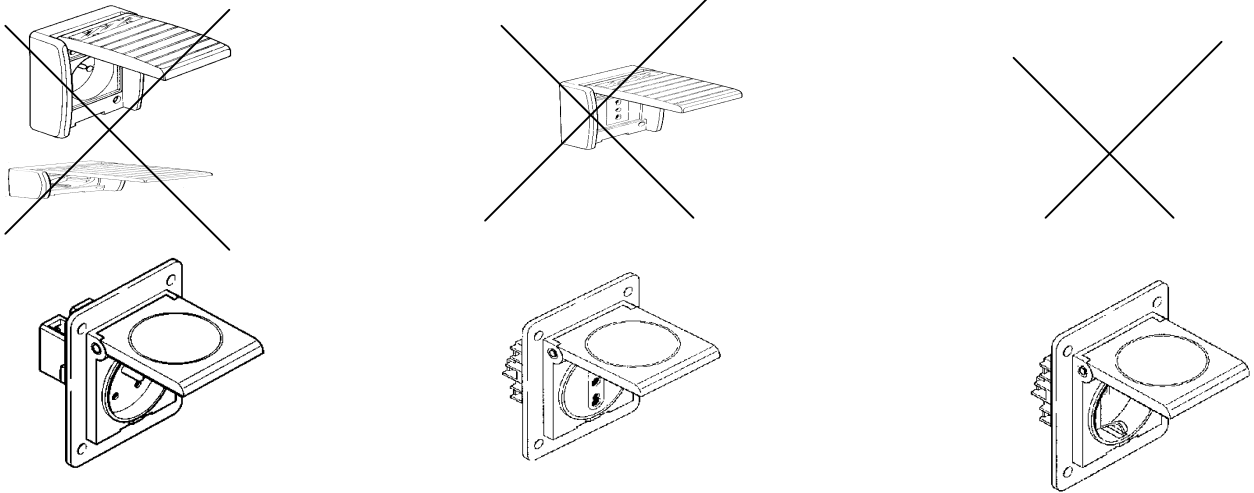

-ART 570 4000 and ART 570 4002 replaced by ART 570 5012

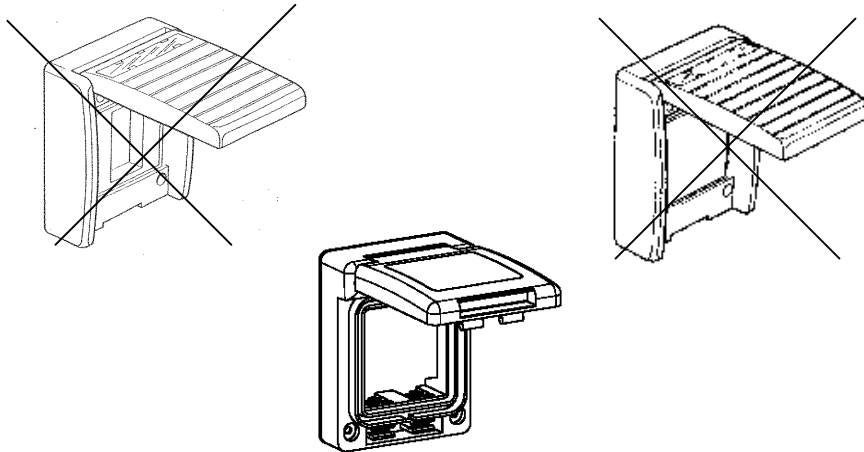

Thank you very much for your kind attention  
Best regards  
EXPORT DEPT  
SCAME PARRE S.p.a.