

> CABLE INLET



Five knockouts for PG11/PG13.5 cable inlets located around the four sides and on the base provide a wide range of installation options: with cable sleeve, with cable gland or with couplings between Ø 16

mm rigid or flexible conduit and box. A flexible conduit for flush mounting and power supply from the rear of the base can also be installed.

> FIXING



MIZAR Series light-fittings are fitted with a slot on the rear of the base for hooking onto a nail, screw or hook, or for fastening to poles, pipes, bars or scaffolding using one

or two cable ties. For permanent installation, the fixtures can be wall or ceiling mounted using screw anchors.

A fast mounting plate for maintaining the protection degree is provided with the IP55 version.

> DIMENSIONS

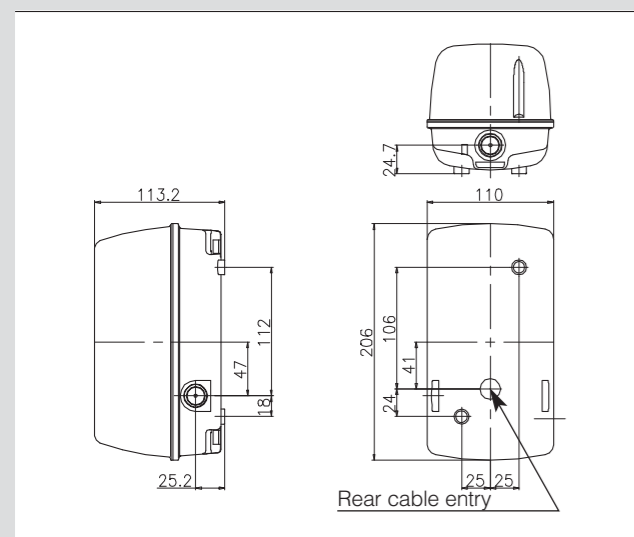

(Dimensions in mm)

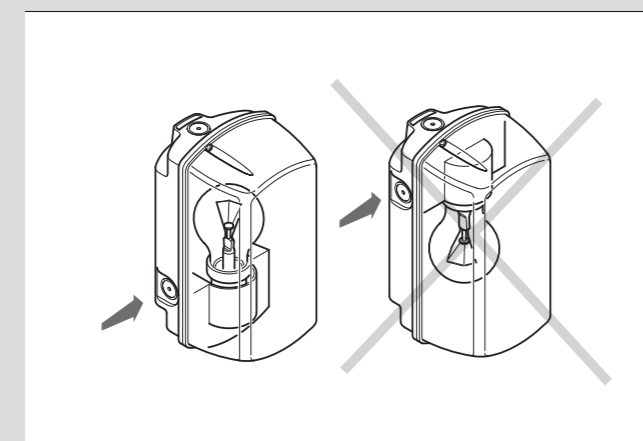

Overheating may affect the life of the lamp-holder and of the cables. To avoid this the lamp must be upright when mounting the fixture vertically, ie the lampholder must be in the lower part of the fixture. This also guarantees the protection degree.

MIZAR Series



> LIGHT FITTINGS



> REFERENCE STANDARDS

EN 60598-1
Luminaires
Part 1: general requirements and tests

EN 60598-2-1
Luminaires
Part 2: specific requirements
Section 1: fixed general purpose luminaires

> QUALITY MARKS



> VERSIONS

 For incandescent lamps - 60W 250V~
- Thermoplastic diffuser - IP44
- Polycarbonate diffuser - IP44 or IP55

 For indicating working areas
- Polycarbonate diffuser - IP44

> TECHNICAL CHARACTERISTICS



Protection degree:	IP44 - IP55
Operating temperature according to the reference standard:	Thermoplastic diffuser: -5°C +35°C Polycarbonate diffuser: -15°C +35°C
Glow Wire test:	650°C
Material:	Engineering plastic
IK degree at 20°C:	IK04 - IK07
Cable inlets:	PG11 - PG13
Double insulation 	Yes (class II)
Lampholder type:	E27 - B22
Installation on inflammable surface:	Yes

> BEHAVIOUR WITH CHEMICAL AND ATMOSPHERIC AGENTS

Saline solution	Acids		Bases		Solvents				Mineral oil	UV rays
	Concentrated	Diluted	Concentrated	Diluted	Hexane	Benzol	Acetone	Alcohol		
Resistant	Limited Resistance	Resistant	Limited Resistance	Limited Resistance	Limited Resistance	Not Resistance	Not Resistance	Resistant	Limited Resistance	Resistant





Light fittings

> RECTANGULAR BULKHEAD LIGHT FOR INCANDESCENT LAMPS - IP44

Lamp power	Lampholder	Colour of diffuser		
Max 60W	E27	opal	12	 780.2762
Max 60W	B22	opal	12	780.2262





- Thermoplastic diffuser. For continuous use, use the version with polycarbonate diffuser. - Lamp not supplied.

> RECTANGULAR BULKHEAD LIGHT FOR INCANDESCENT LAMPS

Lamp power	Lampholder	Colour of diffuser		IP44	IP55
Max 60W	E27	transparent	1/12	 781.2760	 786.2760
Max 60W	E27	red	1/12	 781.2761	 786.2761
Max 60W	B22	transparent	1/12	781.2260	786.2260
Max 60W	B22	red	1/12	781.2261	786.2261

- Polycarbonate diffuser. - Lamp not supplied.



> DISTRIBUTION ASSEMBLIES FOR NIGHT-TIME POWER SUPPLY OF LIGHTS INDICATING WORKING AREAS - IP44

Description	Plug		
Safety transformer 220/24V~-SELV  150VA	2P+E - 16A - 220V	1	630.001
Safety transformer 220/24V~-SELV  300VA	2P+E - 16A - 220V	1	630.002

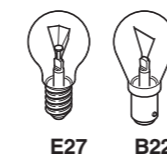
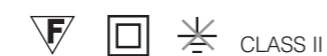

A light sensor turns the lights on and off according to the amount of atmospheric light. With twilight switch. 2 socket outlets, 2P 24V~, 16A. Assembled with SCABOX enclosures.





> FLASHING RED BULKHEAD LIGHT FOR INDICATING WORK SITES - IP55

Description		
Batteries powered - Battery not included.	1/12	786.0100

> RED BULKHEAD LIGHT FOR INDICATING WORK SITES - IP55

Description		
Automatic twilight turn-on and fixed light	1	786.0200
Automatic twilight turn-on Two operation modes: fixed light or flashing light With mode selector switch	1	786.0210
Direct turn-on (without twilight turn-on) and fixed light - With 220V-powered LED flasher.	1	786.0220

> RED BULKHEAD LIGHTS FOR INDICATING WORKING AREAS - IP44

Description		
1 Bulkhead light - 10m cable	1	781.2761/1
2 Bulkhead lights - 10+6m cable	1	781.2761/2
3 Bulkhead lights 10+6+6m cable	1	781.2761/3

- Wired with IEC 309 standard plug, 2P, 24V~ 16A. - Bulb included, E27 25W 24V~.
- Rubber cable, 2x1.5mm². - Diffuser colour, red.