

ART. 205.Wxxx

MONTAGGIO / MOUNTING / MONTAGE / MONTAJE

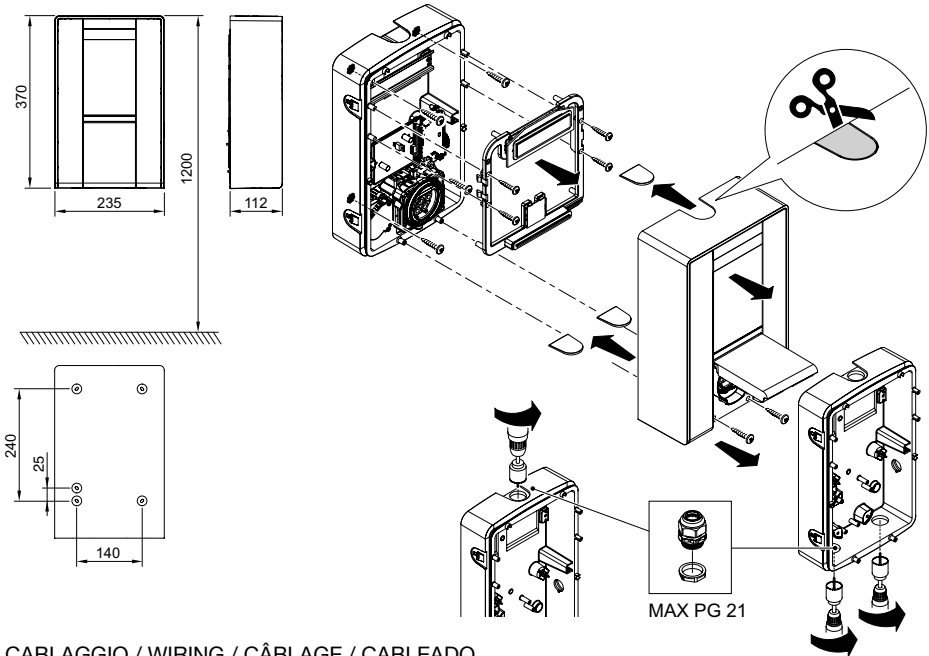

CABLAGGIO / WIRING / CÂBLAGE / CABLEADO

L-N: 220 ÷ 230 Vac
 N-PE : < 5 Vac
 f: 50/60 Hz
 Rt: < 150 Ω
 THD: < 8%

POWER SUPPLY

L	N	PE
---	---	----

2,5+6 mm²

SERIAL LINE

6	8
---	---

0,5 mm²
 ES. BELDEN 9841

(dimensioni in mm) / (dimensions in mm)
 (dimensiones en mm) / (dimensiones en mm)

FUNZIONAMENTO / WORKING / FONCTIONNEMENT / OPERACIÓN

FREE

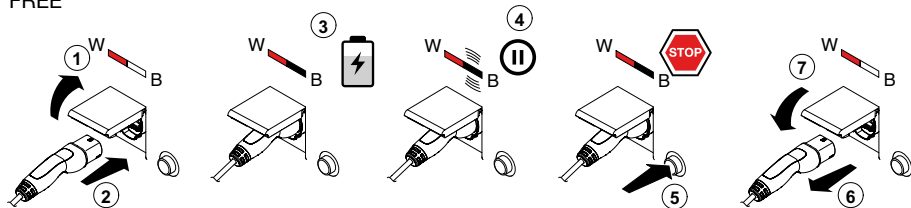

PERSONAL

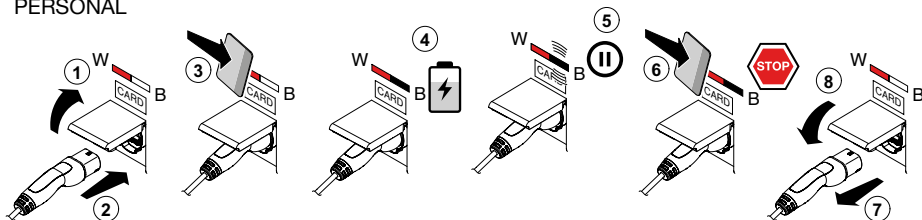

W: WHITE
B: BLUE

CAMBIO MODALITA' / CHANGE MODE / CHANGEMENT DE MODE / CAMBIO DE MODO

Personal → Free

- POWER OFF
- DIP SWITCH 1 SW1: ON
- POWER ON

Free → Personal

- POWER OFF
- DIP SWITCH 1 SW1: OFF
- POWER ON

NOTE / NOTES / NOTES / NOTAS

Questo apparecchio deve essere installato e sottoposto a manutenzione da personale qualificato.
This device shall be installed and maintained by qualified personnel.
Cet appareil doit être installé et entretenu par du personnel qualifié.
Este aparato debe ser instalado y mantenido por personal calificado.

Il costruttore non può essere ritenuto responsabile del mancato rispetto delle presenti istruzioni.
The manufacturer can not be held responsible for any failure to comply with these instructions.
Le fabricant ne peut être tenu responsable du non-respect de ces instructions.
El fabricante no se hace responsable por el incumplimiento de estas instrucciones.

Per scaricare il manuale d'uso delle stazioni di ricarica visitate il nostro sito web:

To download the user manual of charging stations visit our website:

Pour télécharger le manuel d'utilisation des bornes de recharge, visitez notre site web:

Para descargar el manual del usuario de las estaciones de carga, visite nuestro sitio web:

<http://ecomobility.scame.com/download>

POWER MANAGEMENT

Collegamento misuratore di energia aggiuntivo
 Additional energy meter connection
 Connexion de compteur d'énergie supplémentaire
 Conexión de medidor de energía adicional

- <http://ecomobility.scame.com>
- Download: Manuale d'uso POWER MANAGEMENT / User manual / POWER MANAGEMENT / Mode d'emploi POWER MANAGEMENT / Manual de uso POWER MANAGEMENT

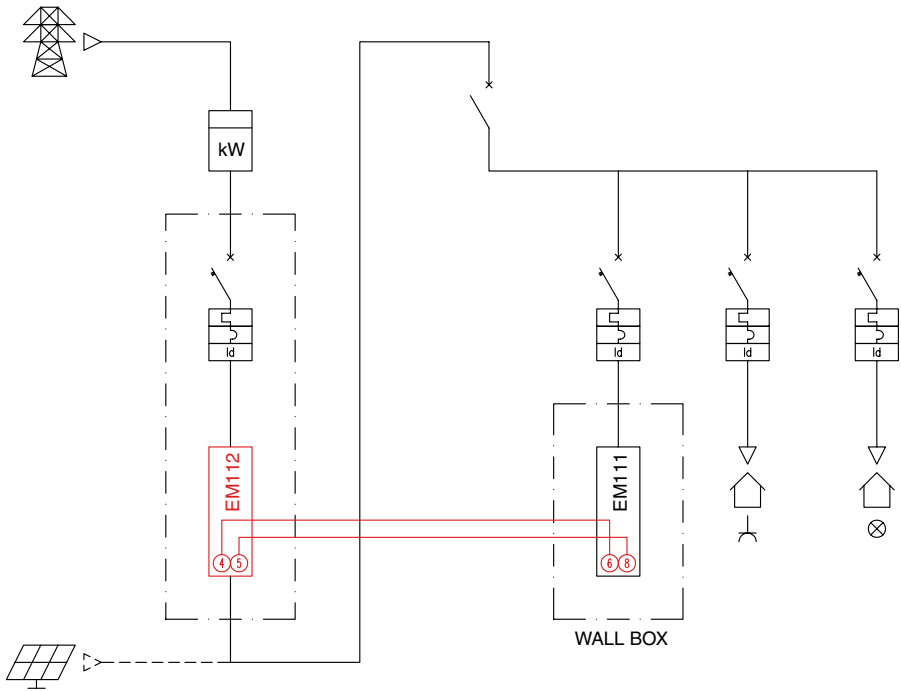

InfoTECH

<p>ITALY</p> <p><small>Numero Verde</small></p> <p style="font-size: 1.2em; font-weight: bold;">800-018009</p>	<p>WORLDWIDE</p> <p>ScameOnLine</p> <p><small>www.scame.com</small></p> <p><small>infotech@scame.com</small></p>
---	--

