

ENCLOSED SWITCH-DISCONNECTORS 100÷160A 3P-3P+N 16÷160A 6P-8P

100÷160A
3P-3P+N

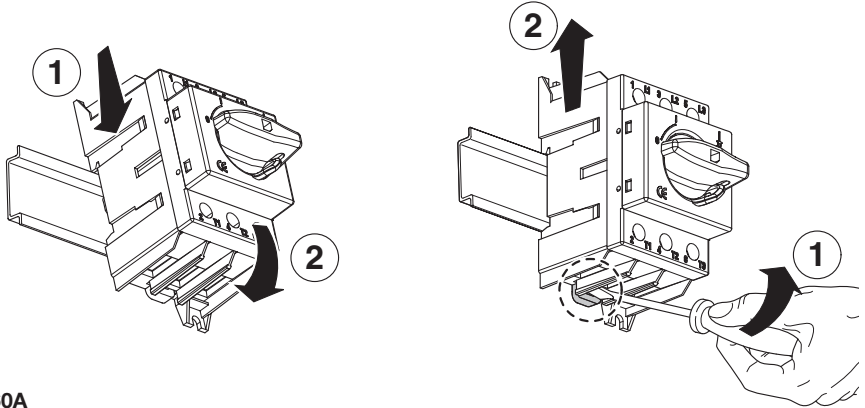

16÷160A
6P-8P

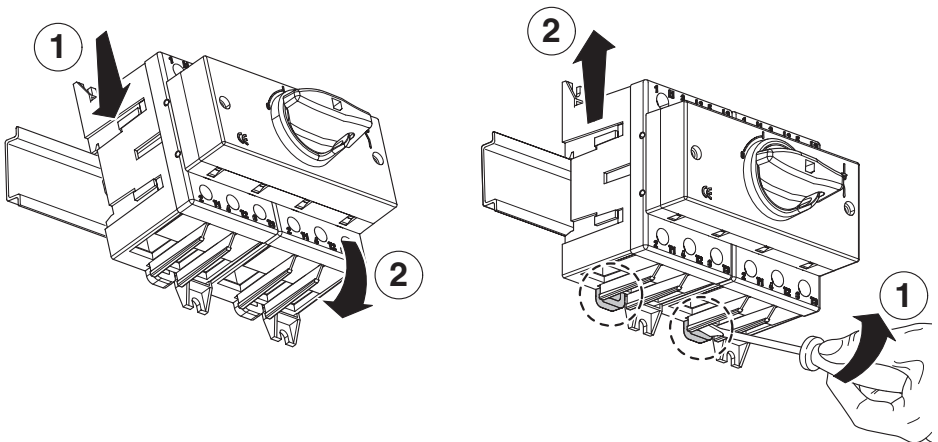

InfoTECH

ITALY

WORLDWIDE

Numero Verde
800-018009

ScameOnLine
www.scame.com
infotech@scame.com

		16÷40A 6P-8P	100A - 3P-3P+N 63-80-100A - 6P-8P	125-160A 3P-3P+N-6P-8P
Wire range		1.5÷16mm ²	10-50mm ²	10-70mm ²
Tightening torque	Terminal screws	2Nm	3.5Nm	6Nm
	Fixing screws	1.2Nm	1.2Nm	1.2Nm
Wire strip length		10mm	13mm	15mm

3 POLES

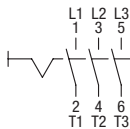

3P+N POLES

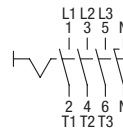

6P POLES

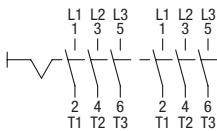

8P POLES

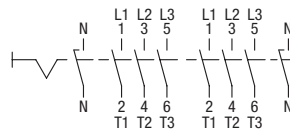

ATTENTION

When mounting or removing additional elements the switch **has to be in OFF position** for avoiding damages to mechanism.

When removing main switch following instruction for avoiding damages.

THERMOPLASTIC ENCLOSURES

**100A 3P-3P+N
16÷40A 6P-8P**

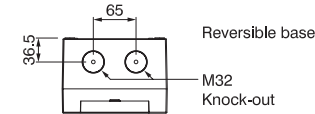
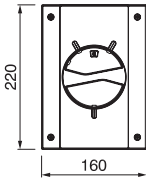

Reversible base
M32
Knock-out

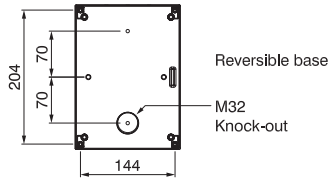

Reversible base
M32
Knock-out

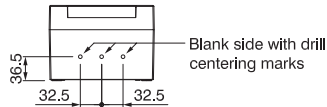

Blank side with drill
centering marks

**125A 3P-3P+N
63-80-100A 6P-8P**

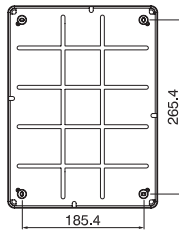
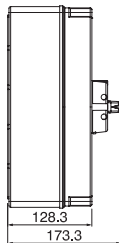
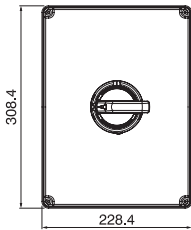

Cable entries		
Top	/	Blank side
Bottom	/	Blank side
Rear	/	Blank side

**125A 6P-8P
160A 3P-3P+N-6P-8P**

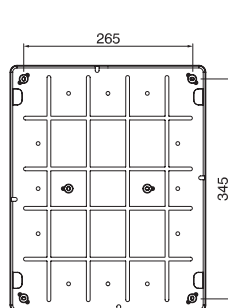
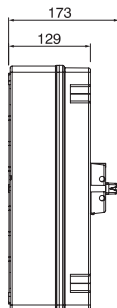
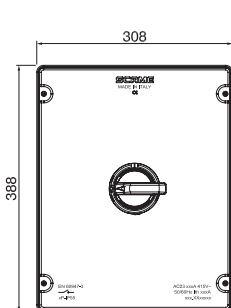

Cable entries		
Top	/	Blank side
Bottom	/	Blank side
Rear	/	Blank side

ALUMINIUM ENCLOSURES

100A 3P-3P+N
16÷40A 6P-8P

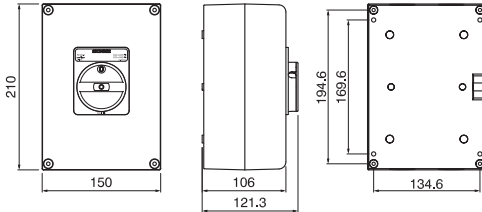

Cable entries		
Top	2xM32	Threaded
Bottom	2xM32	Threaded
Rear	/	Blank side

125A 3P-3P+N
63-80-100A 6P-8P

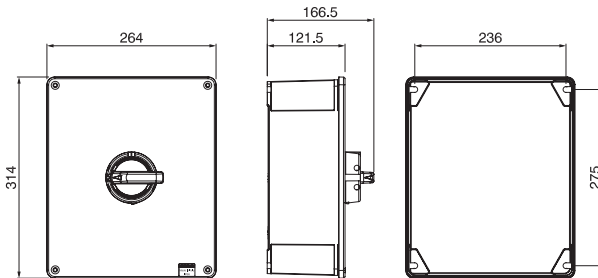

Cable entries		
Top	/	Blank side
Bottom	/	Blank side
Rear	/	Blank side

125A 6P-8P
160A 3P-3P+N-6P-8P

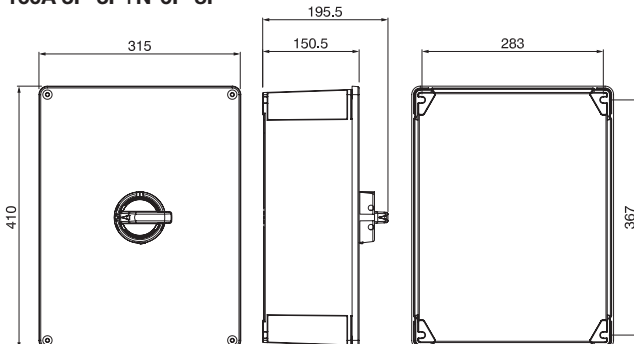

Cable entries		
Top	/	Blank side
Bottom	/	Blank side
Rear	/	Blank side